



OPTIONS : INDICATOR

R F CHARACTERISTICS

FREQUENCY RANGE : 0 - 3 GHz
 IMPEDANCE : 50 Ohms

FREQUENCY (GHz)	0 - 3
V.S.W.R <=	1.20
INSERT. LOSS <=	0.20 dB
ISOLATION >=	80 dB
AVER. POWER (*)	240 W

ELECTRICAL CHARACTERISTICS

ACTUATOR : FAILSAFE
 NOMINAL CURRENT AT 25°C (±10%) : 204 mA
 ACTUATOR VOLTAGE (Vcc) : 28V (24 to 30V)
 TERMINALS : solder pins (250°C max./30 sec.)
 INDICATOR RATING : 1 W / 30 V / 100 mA

MECHANICAL CHARACTERISTICS

CONNECTORS : SMA female per MIL C 39012
 LIFE : 10.000.000 cycles
 SWITCHING TIME (nominal voltage;25°C) : < 10 ms
 CONSTRUCTION : splashproof
 WEIGHT : < 100 g

ENVIRONMENTAL CHARACTERISTICS

OPERATING TEMPERATURE RANGE (°C) : -40 , +85
 STORAGE TEMPERATURE RANGE (°C) : -55 , +85

(* : average power at 25°C)

This information is given as an indication. In the continual goal to improve our products, we reserve the right to make any modifications judged necessary

4112-9212

DRAWING

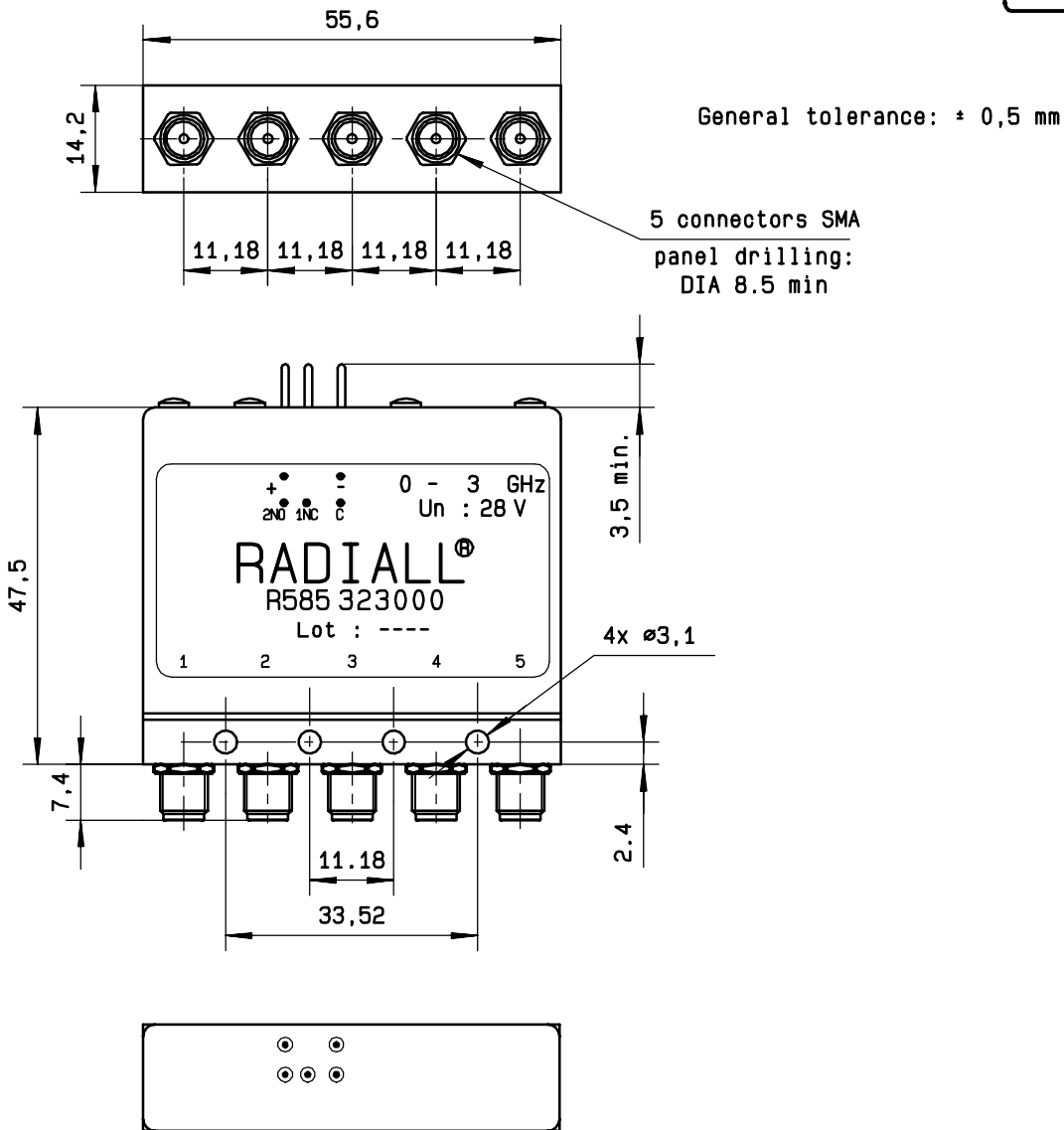

SCHEMATIC DIAGRAM

Voltage	RF continuity	Indicator
De-energized	1 ↔ 2 / 3 ↔ 4	C .1NC
Energized	2 ↔ 3 / 4 ↔ 5	C .2NO

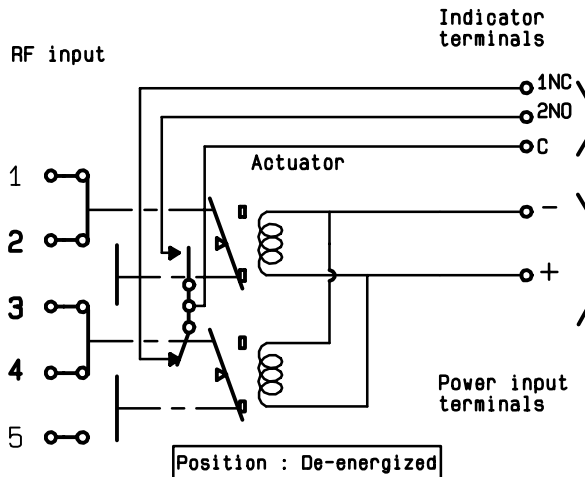

4113-9212 This information is given as an indication. In the continual goal to improve our products, we reserve the right to make any modifications judged necessary